

Screw Pumps & Systems

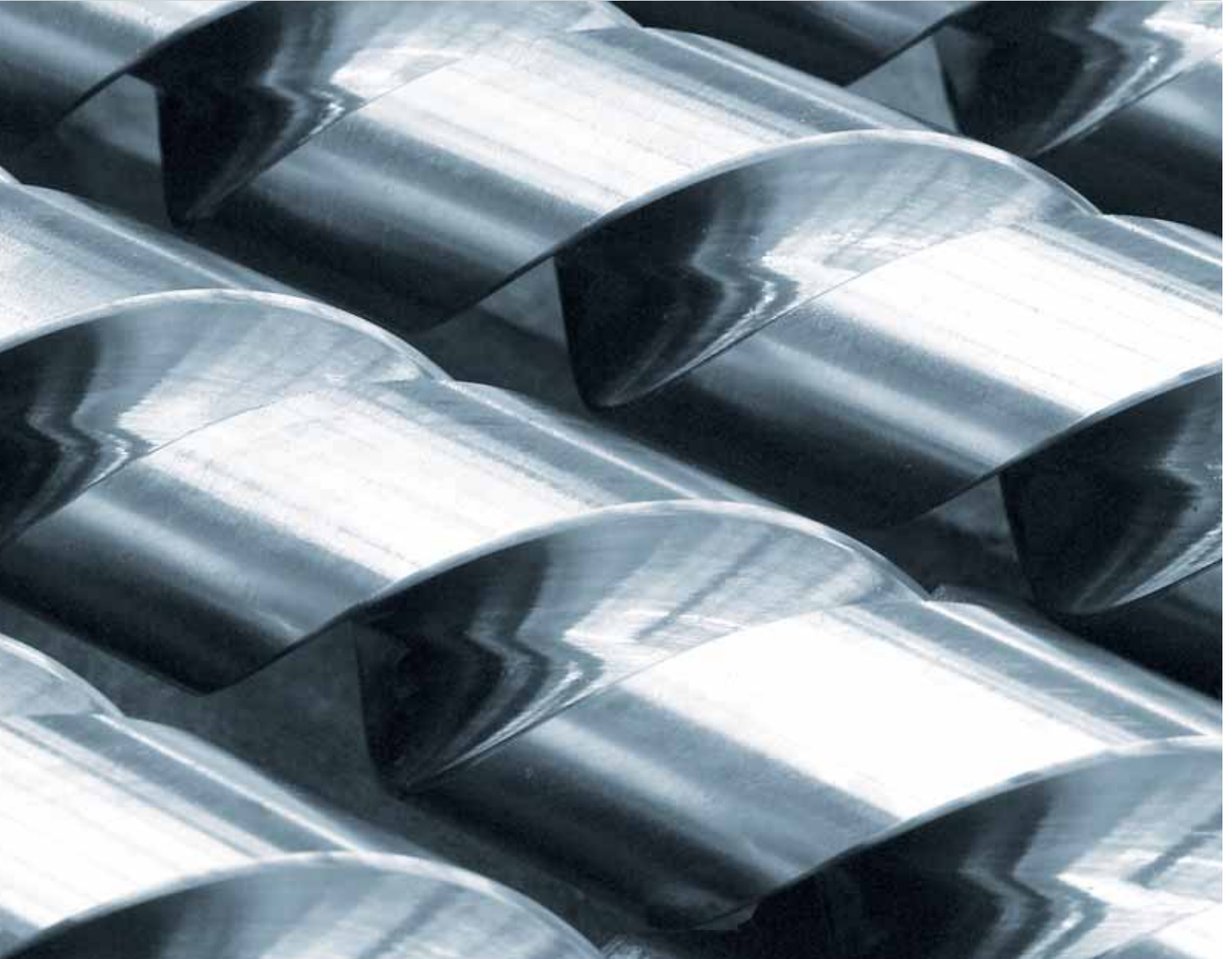

**Storage-,
Export- and
Distribution
Outlets**



Leistriz Screw Pumps and Systems

Leistriz Pumpen GmbH, with its headquarters in Nuremberg/Germany, has been producing Screw Pumps since 1924. The first Leistriz Screw Pump was developed by Paul Leistriz as Main Lube Oil Pump for bearings of steam turbine generator sets.

With the widest product range of Screw Pumps, Leistriz offers today solutions from bare shaft pumps to complete pump packages, being a perfect partner for the Oil & Gas industry.

Leistriz Screw Pumps are serving today's state of the art Oil & Gas processes with the world's most comprehensive range of Twin, Triple and Five Screw Pumps. Leistriz runs both, upstream and downstream application in the oil and gas sector. Terminal operations are using Leistriz Twin Screw, Triple Screw and Five Screw Pumps for loading, unloading, stripping, circulation, transfer, tank cleaning and transport of slops and drains.

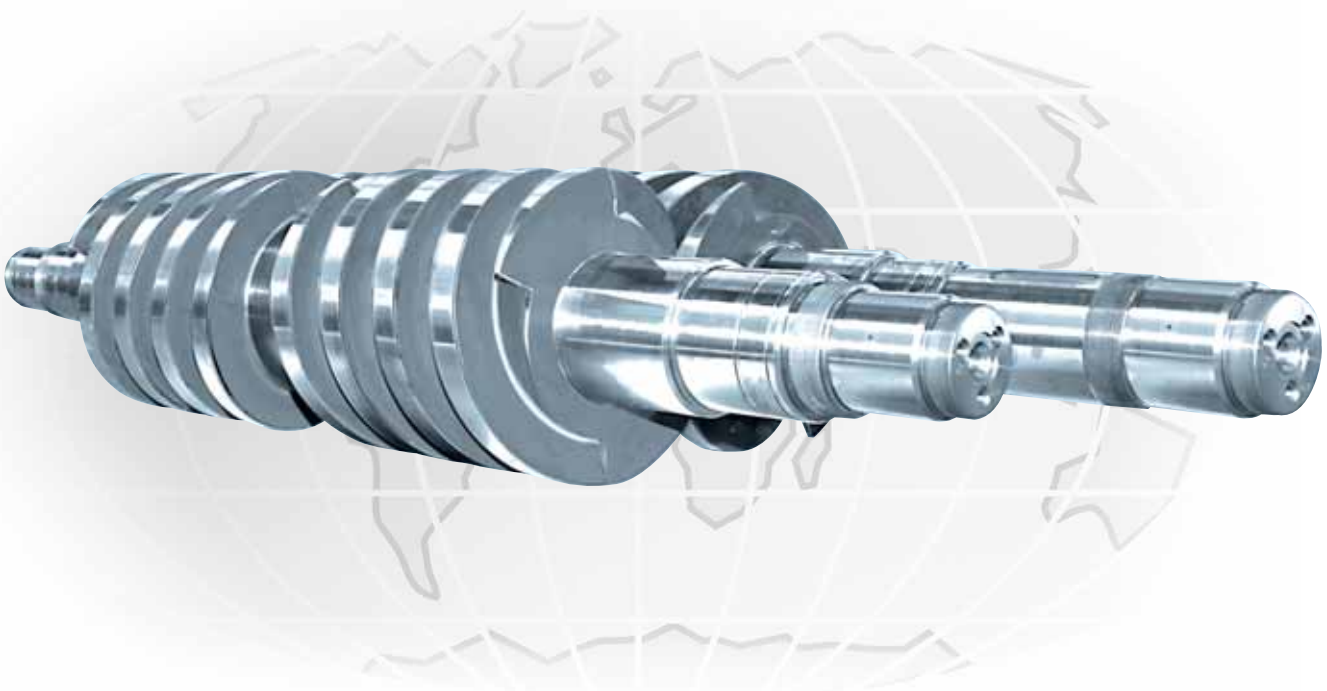

Today's Oil Market Requirements

Rising energy consumption versus limited production locations makes it necessary to have Export-, Distribution- & Storage Outlets, which serve worldwide demands. In the past years a vast number of:

- Oil Trading Centres
- Storage Facilities
- Refineries
- Petroleum Product Distribution Facilities
- Retail Outlets

have been established in strategic areas worldwide. Such facilities are the basis of global oil logistics. Within those facilities Leistriz Screw Pumps are serving all kind of fluid transport and stripping application.



Oil Production, Oil Distribution and Storage

Petrochemical companies continuously increase their output of feedstock and finished products to satisfy the vast growing demand. These production increases require higher storage capabilities and large pumps with high reliability, energy demand, worldwide tight environmental regulations and the reduction of operating costs are in focus of today's end users.

Distribution & Storage facilities offer storage in a controlled environment and the possibility to blend different products in order to satisfy end user demands. Leistritz Screw Pumps and Systems can work under extreme field operating conditions. Duties with:

- Capacities up to 5,000 m³/h
- Discharge Pressures up to 150 bar
- Viscosities up to 150,000 cSt

are reliably handled by Leistritz Screw Pumps.



Storage and Loading Facility in Singapore

Leistritz Pumpen GmbH offers tailor made, high efficiency Screw Pumps. Rotors with Low Pulsation - and Low NPSH_R-Screwprofiles, combined with the typical character of positive displacement pumps, make Leistritz the ideal partner for all terminal operations.

Leistritz Engineered Solutions for Terminal/Storage Application

Leistritz designs Screw Pumps particularly tailored to process requirements.

- No Contact Between Screws and Pump Casing
 - Less Wear from Abrasives in the Fluid, due to Calculated Clearances
 - No Product Contamination by Wear of the Pump Components
 - Handling of Non-Lubricating- / Non-Newtonian-Fluids
- Optimized Rotor Design
 - Improved NPSH Characteristics
 - Lower Tank Level and Longer Suction Lines by better Suction Capabilities
 - Ability to Manifold more/distant Tanks into One Suction Line
 - Wide Range of Fluids and Viscosities Handled by the Same Pump
 - Lower Pumping Temperatures
 - Better Performance with Increased Viscosity due to Reduced Slip Losses
 - Less Vibration
 - Lower Discharge Pulsation
- Optimized Inlet Geometry
 - Low Internal Velocity
 - Low Shear by Transporting Emulsion without Product Separation
 - No Foaming
 - No Change of Product Structure and Properties
 - Improved NPSH Capabilities



Heavy Fuel Oil Unloading Pump in Mexico



Ship Loading Pumps in Singapore



P&ID: Storage-, Export- and Distribution Outlets

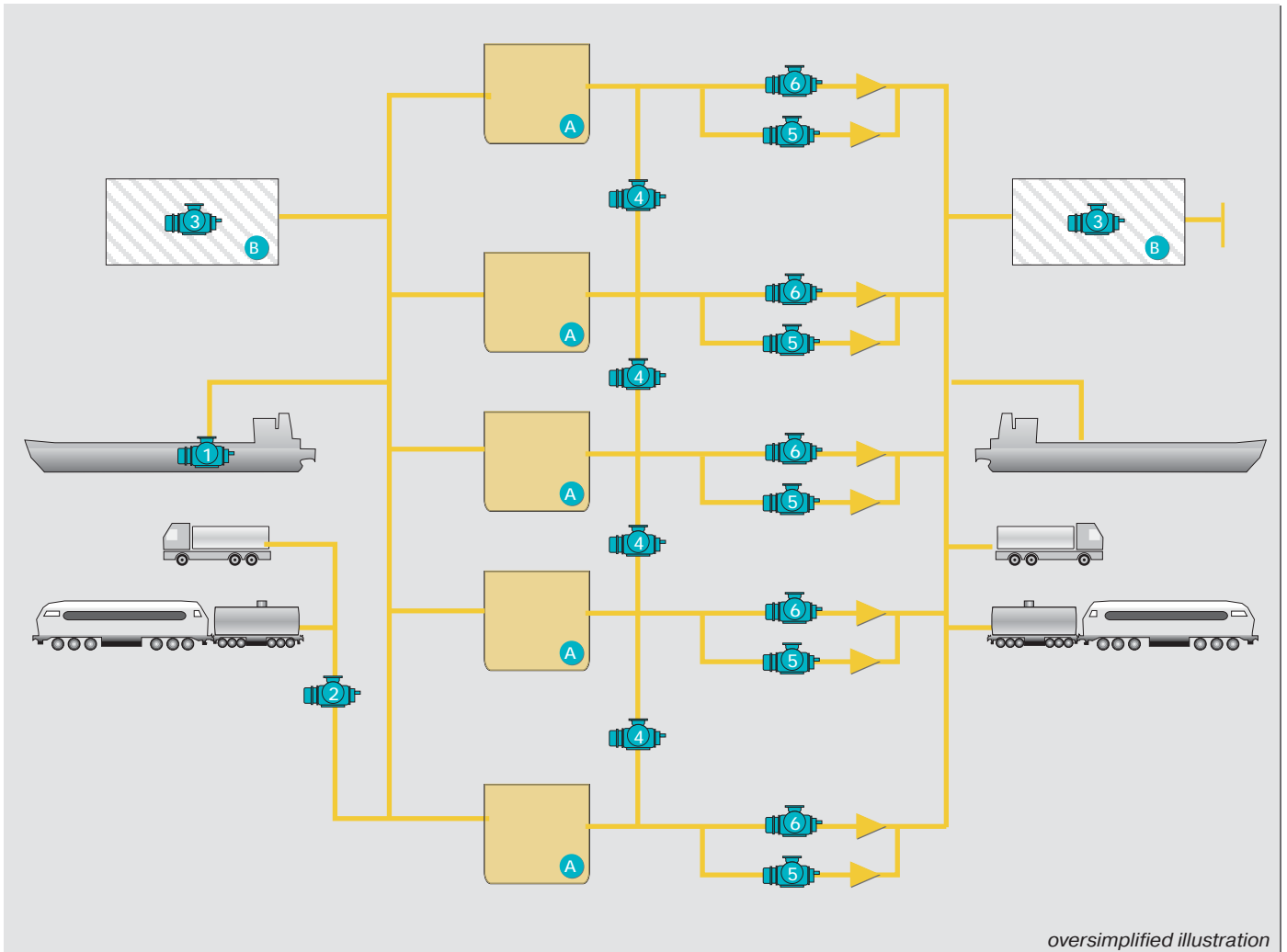

— Crude & Refined Product

- 1 Leistriz On-Board Crude Cargo Pump
- 2 Leistriz Crude Unloading Pump
- 3 Leistriz Booster Pump
- 4 Leistriz Circulation Pump
- 5 Leistriz Stripping Pump
- 6 Leistriz Loading and Transfer Pump

- A Storage Tank
- B Booster Pump Station

Installation and Duties

1 Leistritz On-Board Cargo Pumps L4 and L5

Various types of oil products are unloaded from ships. Preferred pumps for this application are Leistritz Screw Pumps, series L4, with the capability of handling large solid particles contained in the pumped products. The pumps are operating with nitrided screws manufactured from a single piece of bar stock, which offer an excellent service life. The pump liner is replaceable.

Leistritz Screw Pumps, series L5, are also used. This pump type is available in submersible design or as deck mounted unit. Main benefit of this model is the requirement of only one sealing to atmosphere.



1 Leistritz Cargo Pump L4MG

2 Leistritz Unloading Pumps L2, L4 and L5

Unloading of different oils from trucks and railcars are typical applications for Leistritz Screw Pumps, series L2, L4 and L5. L2- and L5-series pumps have only one sealing to atmosphere while the L4-Series can offer an interchangeable liner. All of these pumps have the ability to run dry (L2 and L5 with time limitation), they are self priming and can handle a certain amount of solids.



2 Leistritz HFO Unloading Pump L2NG

3 Leistritz Booster Pump L3

Leistritz high pressure Triple Screw Pumps, series L3, are well suited for pipeline booster applications in pumping stations. Due to their triple screw design, the pumps can handle crude oil with a wide range of viscosities and generate differential pressures up to 160 bar even when pumping very light crudes.



3 Leistritz HFO Booster Pump L3MG

4 Leistritz Circulation Pumps L2, L3 and L4

Tank stored Crude Oil must be circulated to avoid separation and to maintain the temperature. It is particularly important to maintain a homogeneous product quality with constant viscosity over the entire tank volume. Additionally, the system pipe work must be regularly flushed to prevent adhesion of wax or other substances reducing the nominal diameters. Leistritz Screw Pumps, series L2, L3 and L4, are used to circulate the product reliably through the system pipe work and/or heaters.



4 Leistritz Oil Circulation Pump L4NG

5 Leistritz Stripping Pump L4

The product remaining on the bottom of the crude storage tanks is normally of heavy and high viscous nature and contains solids. Low speed Leistritz Screw Pumps, series L4, with excellent suction capabilities and the ability to run dry are preferred for tank stripping. Variable speed operation along with a special screw design guarantees excellent $NPSH_R$ values and minimized pulsation.



5 Leistritz Crude Oil Stripping Pump L4MG

6 Leistritz Loading and Transfer Pump L2, L3, L4 and L5

A variety of oil based products are transferred from the storage tanks to ships, railcars and trucks for transportation to the end users. Leistritz Screw Pumps of all series are used in these applications. Leistritz Screw Pumps, series L2 and L3, are transferring both, light and heavy oil to different storage facilities and to load trucks and railcars.

With their excellent suction capability and low pulsation, L4-pumps are used for higher flow rates. These pumps handle viscosities of more than 3,000 cSt. A special screw design guarantees very low $NPSH_R$ values.

Flow rates up to 5,000 m^3/h permit short loading periods resulting in low port fees for ocean going vessels. Leistritz Screw Pumps, series L5, are also used for high flow rates and pressures up to 10 bar.



6 Leistritz HFO Transfer Pump L4MG



Customer Service - Pump Test Field - Quality Assurance

Customer Service

Leistriz Screw Pumps are products of continuous customer oriented optimization and development. Professional Leistriz Customer Service is based on worldwide, close and long term partnership with engineers, operators and endusers. Leistriz performs:

- Inspection, Maintenance and Repair
- Service and Maintenance Contracts
- Installation, Commissioning and Retrofits
- Delivery and Installation of Genuine Leistriz Spare Parts
- Training
- Pump Operations under Test Conditions
- Project Supervision
- 24h Service

Test Fields

Oil- and Water- Test Fields for individual parameter check and control

- 5 Test Stands
- 4 MW Test Field
- Computer Controlled Recording of Measurement Reading
- Large Volume Tanks for Long Test Periods

Quality Assurance

Latest technology in combination with strictly controlled quality is the basis for the worldwide known Leistriz Screw Pump reliability and efficiency. Leistriz Quality Assurance concentrates on compliance with highest quality standards, e.g.:

- Use of Latest CMM Technology
- Constant Monitoring of all Manufacturing Processes for Small Tolerances
- Strict Tolerance Compliances for High Pump Efficiency and Low Life Cycle Costs
- Know-How-Transfer Due to Close Collaboration with Universities and Independent Institutes

Certificates

Leistriz Pumpen GmbH is Certified According to:

- DIN EN ISO 9001:2000
- DIN EN ISO 14001:2005
- OHSAS 18001
- RS Supervisor
- ROSTECHNADZOR
- GOST-R
- GOST-K



Leistriz Overhaul Team



Professional Site Inspection



Leistriz Multiphase Test Field



Leistriz Certificates



Monitoring of all Manufacturing Processes

User Advantages of Leistritz Screw Pumps

Operating Benefits Provided by Leistritz

- Design in Accordance with API 676, Latest Edition
- Made for Outdoor Installation and Operation
- Compact Design
- Replaceable Liners
- Screws and Shafts are Made of a Single Piece of Bar Stock Material for Maximum Stiffness and Minimum Shaft Deflection
- Screw Hardening for Extraordinary Long Service Life
- Leistritz Screws are Available in Special "Low-Vibration-Design"
- Leistritz Screws are Available in Special "Low-NPSH_R-Design"
- Rotor System is Hydraulically Balanced
- Mechanical Seals (Double or Single Arrangements) are Exposed to Suction Condition only for Longer Seal Life, Less Leakage and Lower Load on Seal and Shaft
- Suitable Seal Flushing in Accordance with API as an Integral Part of the Pump Package/Skid
- Leistritz Twin Screw Pumps are Equipped with Heavy Duty, Pre-Loaded Tapered Roller Bearings with a L10 Life of min 25,000 Hours
- Leistritz Screw Pumps Handle High Viscous Products with Excellent Efficiencies up to 90%, Resulting into Comparable Low Power Consumption
- Leistritz Screw Pumps Deliver a Constant Flow Rate at Different Viscosities and Differential Pressures
- Self-Priming Capability up to 9 mwc
- Directly Driven by Electric Motors or Combustion Engines up to 3,500 rpm with no Requirement for Gear Boxes or Belt Drives
- Variable Speed Drive Operation for Normal Duty and Stripping with One Pump Only
- Temperature Range: -20 to +350°C
- Made in Germany!





Assembly Hall of Leistritz Pumpen GmbH



Leistritz Nuremberg Facilities

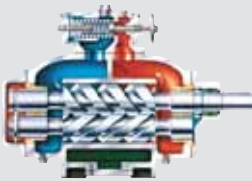
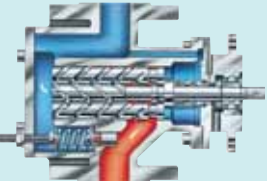
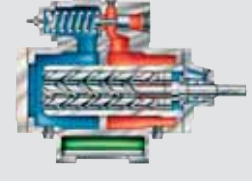

Leistriz Screw Pumps and Systems

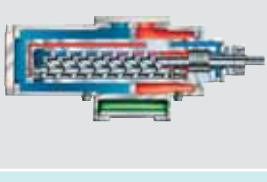
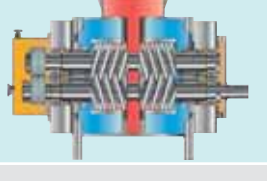
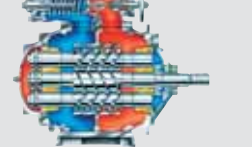
Series	Use for	Leistriz Screw Pump	Maximal Performance Data			
			Capacity	Differential Pressure	Viscosity	Pumping Temperature
L2	Low pressure duty, suitable for transport of light abrasive and corrosive, high or low viscous fluids with poor or good lubricity.		900 m ³ /h [3,960 gpm]	16 bar [232 psi]	100,000 cSt	280°C [536°F]
L3N	Low pressure duty, suitable for transport of non abrasive lubricating fluids.		700 m ³ /h [3,100 gpm]	16 bar [232 psi]	15,000 cSt	180°C [356°F]
L3M	Medium pressure duty, suitable for transport of non abrasive lubricating fluids.		300 m ³ /h [1,320 gpm]	80 bar [1,160 psi]	10,000 cSt	280°C [536°F]
L3H	High pressure duty, suitable for transport of non abrasive lubricating fluids.		200 m ³ /h [880 gpm]	160 bar [2,320 psi]	10,000 cSt	280°C [536°F]
L3V/U	Ultra high pressure duty suitable for transport of light abrasive and corrosive, high or low viscous fluids with poor or good lubricity.		180 m ³ /h [792 gpm]	280 bar [4,060 psi]	1,000 cSt	280°C [536°F]
L4	Low, medium and high pressure duty, suitable for transport of abrasive/non abrasive, corrosive/non corrosive, lubricating/non lubricating, high or low viscous fluids.		5,000 m ³ /h [22,000 gpm]	150 bar [2,175 psi]	150,000 cSt	350°C [662°F]
L5	Low pressure duty, suitable for transport of light abrasive and corrosive, high or low viscous fluids with poor or good lubricity.		1,700 m ³ /h [7,500 gpm]	10 bar [145 psi]	100,000 cSt	280°C [536°F]

Exceeding operating conditions upon request.

LEISTRITZ PUMPEN GMBH
P.O. Box 30 41
D-90014 Nuremberg
Markgrafenstrasse 29-39
D-90459 Nuremberg
Phone: +49 9 11/43 06 - 0
Fax: +49 9 11/43 06 - 490
E-Mail: pumps@leistriz.com
www.leistriz.com

LEISTRITZ ITALIA SRL
Via dei Fontanili, 26
I-20141 Milan
Italy
Phone: +39 / 02 84 477 451
+39 / 02 84 477 505
Fax: +39 / 02 84 477 444
E-Mail: pompeitalia@leistriz.com
www.leistriz.com

Your Leistriz Partner: